

YAMAHA AVX-700

Natural Sound Stereo Amplifier

Préamplificateur stéréo de la série "Natural Sound"



CENTER

OWNER'S MANUAL
MODE D'EMPLOI

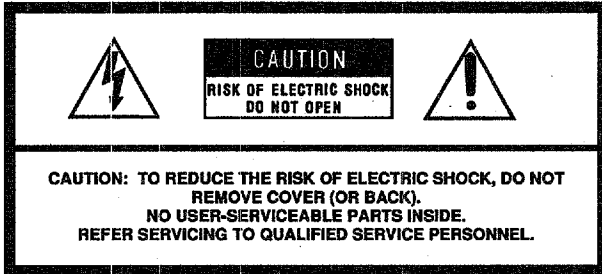

● Explanation of Graphical Symbols



The lightning flash with arrowhead symbol, within an equilateral triangle, is intended to alert you to the presence of uninsulated "dangerous voltage" within the product's enclosure that may be of sufficient magnitude to constitute a risk of electric shock to persons.



The exclamation point within an equilateral triangle is intended to alert you to the presence of important operating and maintenance (servicing) instructions in the literature accompanying the appliance.

IMPORTANT

Please record the serial number of your unit in the space below.

Model: **AVX-700**
Serial No.:

Keep this owner's manual in a safe place for future reference.

SAFETY INSTRUCTIONS

1 Read Instructions — All the safety and operating instructions should be read before the appliance is operated.

2 Retain Instructions — The safety and operating instructions should be retained for future reference.

3 Heed Warnings — All warnings on the appliance and in the operating instructions should be adhered to.

4 Follow Instructions — All operating and other instructions should be followed.

5 Water and Moisture — The appliance should not be used near water — for example, near a bathtub, washbowl, kitchen sink, laundry tub, in a wet basement, or near swimming pool, etc.

6 Carts and Stands — The appliance should be used only with a cart or stand that is recommended by the manufacturer.

6A An appliance and cart combination should be moved with care. Quick stops, excessive force, and uneven surfaces may cause the appliance and cart combination to overturn.



7 Wall or Ceiling Mounting — The appliance should be mounted to a wall or ceiling only as recommended by the manufacturer.

8 Ventilation — The appliance should be situated so that its location or position does not interfere with its proper ventilation. For example, the appliance should not be situated on a bed, sofa, rug or similar surface, that may block the ventilation openings; or placed in built-in installation, such as a bookcase or cabinet that may impede the flow of air through the ventilation openings.

9 Heat — The appliance should be situated away from heat sources such as radiators, stoves, or other appliances that produce heat.

10 Power Sources — The appliance should be connected to a power supply only of the type described in the operating instructions or as marked on the appliance.

11 Power-Cord Protection — Power-supply cords should be routed so that they are not likely to be walked on or pinched by items placed upon or against them, paying particular attention to cords at plugs, convenience receptacles, and the point where they exit from the appliance.

12 Cleaning — The appliance should be cleaned only as recommended by the manufacturer.

13 Nonuse Periods — The power cord of the appliance should be unplugged from the outlet when left unused for a long period of time.

14 Object and Liquid Entry — Care should be taken so that objects do not fall into and liquids are not spilled into the inside of the appliance.

15 Damage Requiring Service — The appliance should be serviced by qualified service personnel when:

- A.** The power-supply cord or the plug has been damaged; or
- B.** Objects have fallen, or liquid has been spilled into the appliance; or
- C.** The appliance has been exposed to rain; or
- D.** The appliance does not appear to operate normally or exhibits a marked change in performance; or
- E.** The appliance has been dropped, or the cabinet damaged.

16 Servicing — The user should not attempt to service the appliance beyond those means described in the operating instructions. All other servicing should be referred to qualified service personnel.

17 Power Lines — An outdoor antenna should be located away from power lines.

18 Grounding or Polarization — The precautions that should be taken so that the grounding or polarization of an appliance is not defeated.

Remote Control Transmitter
Emetteur de télécommande

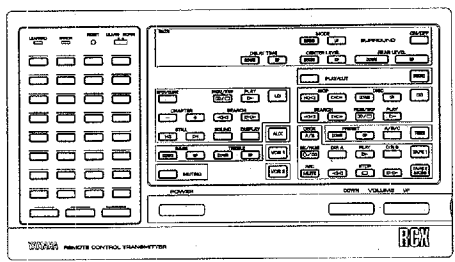

Remote Control Cable (5-pin, tuner)
Câble de télécommande (5 broches, syntoniseur)

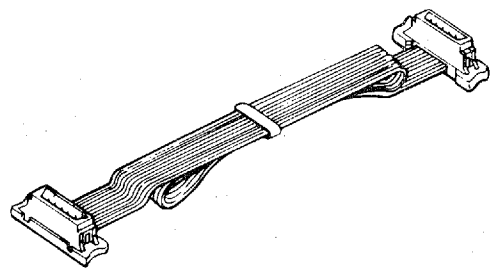

Video Cord
Câble vidéo

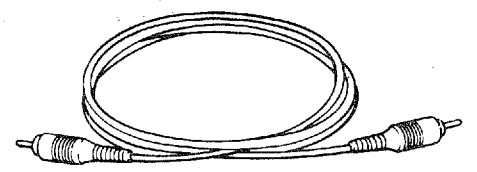

Batteries (size "AA", R06)
Piles (Taille "AA", R06)

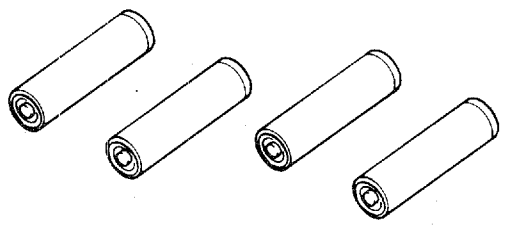

Remote Control Cable (6-pin, cassette deck)
Câble de télécommande (6 broches, platine à cassette)

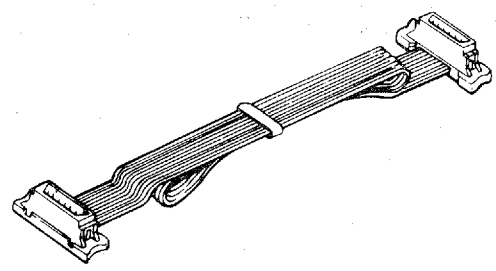

Seals and Tweezers
Etiquettes et pinces

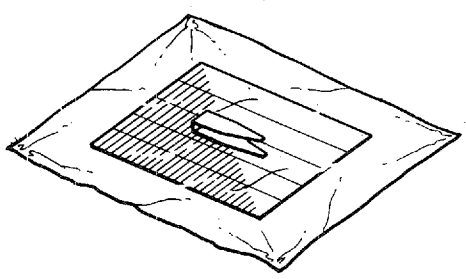

Remote Control Cable (mini-plug, turntable)
Câble de télécommande (mini-prise, platine tourne-disque)

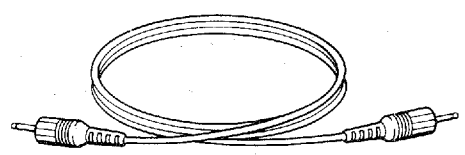

2

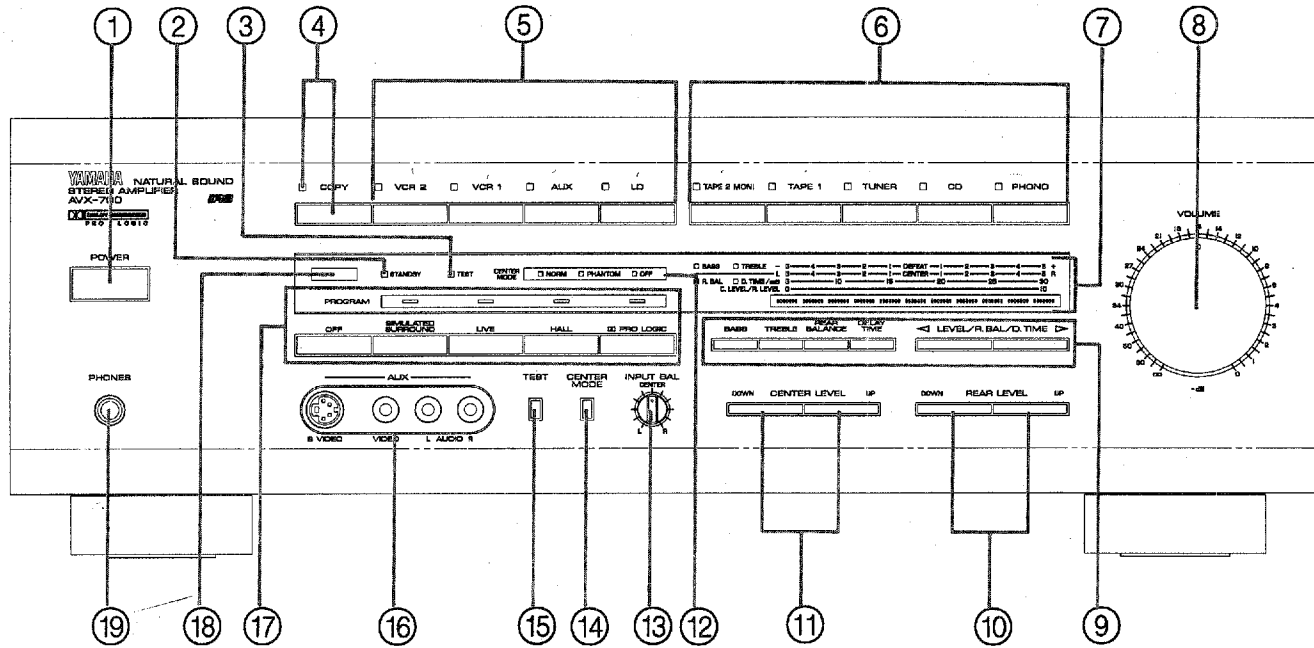

3

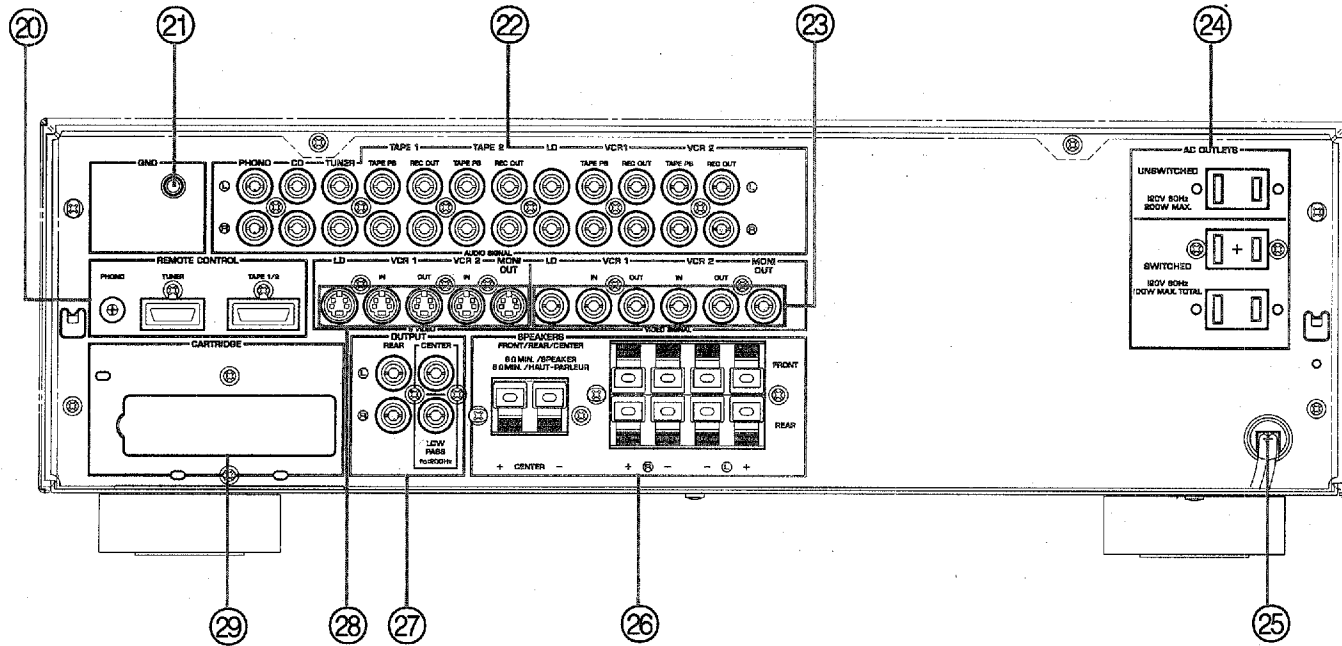

4

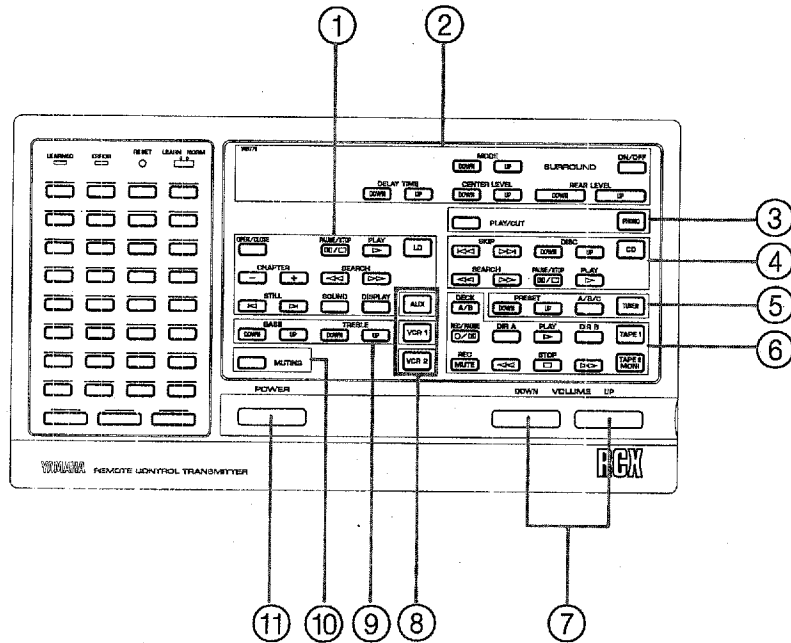

5

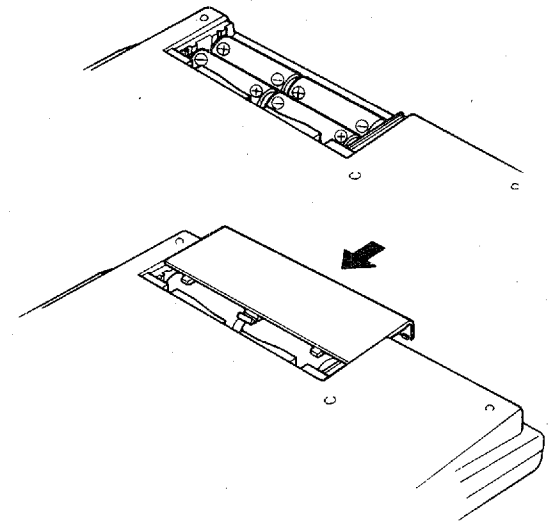

6

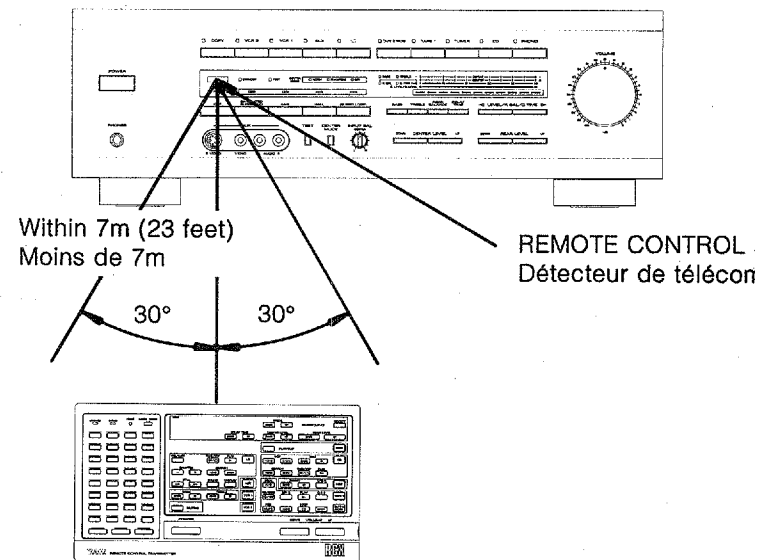

- Thank you for purchasing the YAMAHA AVX-700 stereo amplifier.

CAUTION: READ THIS BEFORE OPERATING YOUR AVX-700

1. To ensure the finest performance, please read this manual carefully. Keep it in a safe place for future reference.
2. Install your unit in a cool, dry, clean place — away from windows, heat sources, and too much vibration, dust, moisture, or cold. Avoid sources of hum (transformers, motors.). To prevent fire or electrical shock, do not expose to rain and water.
3. Never open the cabinet. If a foreign object drops into the set, contact your dealer.
4. Do not use force on switches, knobs or cords. When moving the unit, first disconnect the power plug and the cords connecting the other equipment. Never pull the cord itself.
5. Always set the volume control of the amplifier to “-∞” while lowering the tonearm to play a record; turn the volume up with the stylus in the groove.
6. Do not attempt to clean the unit with chemical solvents; this might damage the finish. Use a clean, dry cloth.
7. Be sure to read the “troubleshooting” section on common operating errors before concluding that your unit is faulty.

8. Do not connect audio equipment to the AC outlets on the rear panel if that equipment requires more power than the outlets are rated to provide.
9. If your unit has a voltage selector (General model only), check that it is set to your local voltage before you plug it in. If not properly set, reset the switch to indicate your supply voltage.

WARNING

TO REDUCE THE RISK OF FIRE OR ELECTRIC SHOCK, DO NOT EXPOSE THIS APPLIANCE TO RAIN OR MOISTURE.

CAUTION FOR CANADA MODEL

TO PREVENT ELECTRIC SHOCK DO NOT USE THIS (POLARIZED) PLUG WITH AN EXTENSION CORD, RECEPTACLE OR OTHER OUTLET UNLESS THE BLADES CAN BE FULLY INSERTED TO PREVENT BLADE EXPOSURE.

THIS DIGITAL APPARATUS DOES NOT EXCEED THE “CLASS B” LIMITS FOR RADIO NOISE EMISSIONS FROM DIGITAL APPARATUS SET OUT IN THE RADIO INTERFERENCE REGULATION OF THE CANADIAN DEPARTMENT OF COMMUNICATIONS.

Special Instructions for U.K. Model

IMPORTANT

The wires in the mains lead are coloured in accordance with the following code:

Blue: NEUTRAL

Brown: LIVE

As the colours of the wires in the mains lead of this apparatus may not correspond with the coloured markings identifying the terminals in your plug, proceed as follows. The wire which is coloured BLUE must be connected to the terminal which is marked with the letter N or coloured BLACK. The wire which is coloured BROWN must be connected to the terminals which is marked with the letter L or coloured RED.

SUPPLIED ACCESSORIES

(See Fig. 1.)

After unpacking, check that the following parts are contained.

- Remote control transmitter
- Batteries (size "AA")
- Remote control cable (5-pin, tuner)
- Remote control cable (6-pin, cassette deck)
- Remote control cable (mini-plug, turntable)
- Video cord
- Seals and Tweezers

CONTROLS AND THEIR FUNCTIONS

■ FRONT PANEL (See Fig. 2.)

① POWER switch

This switch is used to turn the power to the unit on and off. Press it to supply power and press it again to turn the power off.

② STANDBY indicator

When the POWER key on the remote control transmitter is pressed to turn off the power instead of the POWER switch on the front panel, the STANDBY indicator lights. In this state, pressing the POWER key on the remote control transmitter again turns the power on and the STANDBY indicator goes off. To completely turn off the power, press the POWER switch on the front panel.

③ TEST indicator

Flashes during test mode.

④ COPY button and indicator

When this button is pressed, the indicator lights and this unit outputs only the video/audio signal of the video source selected with one of the video input selectors at REC OUT jacks.

Once this button is pressed, the recording source is determined and the other video input selectors cannot function.

⑤ Video input selectors

These selectors are used to select the video source you wish to monitor (Video Cassette Recorder 2, Video Cassette Recorder 1, Auxiliary, or *LD player). When one of these selectors is pressed, the corresponding indicator lights.

* "LD player" is short for Laser vision Disc player.

⑥ Audio input selectors

These selectors are used to select the audio source you wish to monitor (Tape deck 2, Tape deck 1, Tuner, CD player, or Turntable). When one of these selectors is pressed, the corresponding indicator lights.

The TAPE 2 MONI selector is also used to monitor the sound to be recorded while recording is being carried out on tape deck 2.

⑦ Bass/Treble, Rear balance, Delay time, Center Level/Rear level indicators and meters

BASS/TREBLE indicators: The BASS indicator lights when the low frequency response is being adjusted, and the TREBLE indicator lights when the high frequency response is being adjusted. The meter shows the adjusted level with lighted segments.

R.BAL (Rear balance) indicator: When adjusting the relative volume levels of the left and right rear speakers, this indicator lights and the meter shows the shifted sound image with lighted segments.

D.TIME/mS indicator: When adjusting the sound delay time to the rear speaker pair, this indicator lights and the meter shows the adjusted delay time in milliseconds.

C.(Center) LEVEL/R.(Rear) LEVEL: When adjusting the volume level of the center speaker or rear speakers, the meter shows the adjusted volume level with lighted segments.

⑧ VOLUME control and indicator

This control is used to adjust the output volume level. Turning the control clockwise increases the sound level, and turning it counterclockwise decreases the sound level. This control acts as the master volume control; it increases and decreases the volume level to the front and rear speaker pairs and center speaker.

⑨ BASS, TREBLE, REAR BALANCE, and DELAY TIME buttons and LEVEL/R.BAL/D.TIME controls

When adjusting the low frequency or high frequency response, press the BASS button or TREBLE button and adjust the level with the LEVEL/R.BAL/D.TIME (◀, ▶) controls.

When adjusting the relative volume levels of the left and right rear speakers, press the REAR BALANCE button and adjust the level with the LEVEL/R.BAL/D.TIME (◀, ▶) controls.

When varying the delay time to the rear speaker pair, press the DELAY TIME button and vary the level of the delay time with the LEVEL/R.BAL/D.TIME (◀, ▶) controls.

Pressing the ▶ control increases the level and pressing the ◀ control decreases the level.

⑩ REAR LEVEL controls

These controls are used to adjust the volume level of the rear speakers. Press the UP control to raise the volume level and press the DOWN control to lower it.

⑪ CENTER LEVEL controls

These controls are used to adjust the volume level of the center speaker. They do not affect subwoofer output (connected to the lower CENTER jack). Press the UP control to raise the volume level and press the DOWN control to lower it.

⑫ CENTER MODE (NORM/PHANTOM/OFF) indicators

In Dolby Pro Logic Surround mode, the center speaker mode can be selected with the CENTER MODE button and the corresponding indicator (NORM, PHANTOM or OFF) lights.

⑬ INPUT BALANCE control

Use this control to obtain the best surround condition.

⑭ CENTER MODE button

In Dolby Pro Logic Surround mode, this button is used to select the center speaker mode. When the center speaker is used (5-speaker system), set this button to NORM. Conversely, when the center speaker is not used (4-speaker system), set this button to PHANTOM.

When adjusting the surround condition, set this button to OFF to cut off the sound from the center speaker.

⑮ TEST button

When this button is pressed in Dolby Pro Logic Surround mode, the unit generates a pink noise signal that is sent in succession to the right, center, left, and rear speakers. This function is useful for adjusting the output level of the various speakers from the listening position.

⑯ AUX jacks

These jacks are used to connect an auxiliary video or audio input source, such as a video camera, to the amplifier.

⑰ Surround PROGRAM buttons and indicators

These buttons are used to select a Surround Program. When the SIMULATED SURROUND, LIVE, HALL, or  PRO LOGIC button is pressed, the corresponding indicator lights. When surround sound is not desired, press the OFF button. For details, see the "SURROUND PROGRAMS" section.

⑱ Remote control sensor

Receives the signal from the remote control transmitter.

⑲ PHONES jack

This jack is used when privately listening to the sound using headphones. Insert the headphones plug into this jack. When headphones are plugged into this jack, the sound to the speakers is cut off.

■ REAR PANEL (See Fig. .)

⑳ REMOTE CONTROL cable connectors

These connectors are used to connect compatible YAMAHA components equipped with a remote control terminal (marked with an ) to your amplifier to enable remote control of each component. Cables for various components are supplied with this unit.

PHONO — Connect to a turntable using the cable with the mini-plug connector.

TUNER — Connect to a tuner using the cable with the 5-pin connector.

TAPE 1/2 — Connect a cassette tape deck using the cable with the 6-pin connector.

㉑ GND terminal

Connect to the ground wire of your turntable.

㉒ AUDIO SIGNAL jacks

These jacks are used to connect the audio signal cables from your components to the amplifier. They should be connected to the proper input/output jacks of each unit. Be sure that the L and R channels are connected properly.

PHONO — Connect to a turntable.

CD — Connect to a compact disc player.

TUNER — Connect to a tuner.

TAPE 1 — Connect to a cassette tape deck for both recording and playback.

TAPE 2 — Connect to a second cassette tape deck for both recording and playback.

* If you have only one cassette tape deck, connect it to the TAPE 2 jacks. This allows you to monitor the sound to be recorded by setting the front panel TAPE 2 MONI selector.

LD — Connect to an LD player.

VCR 1 — Connect to a video cassette recorder for both recording and playback.

VCR 2 — Connect to a second video cassette recorder for both recording and playback.

㉓ VIDEO SIGNAL jacks

LD — Connect to an LD player.

VCR 1 — Connect to a video cassette recorder for both recording and playback.

VCR 2 — Connect to a second video cassette recorder for both recording and playback.

MONI OUT — Connect to the video IN terminal on a TV monitor.

㉔ AC OUTLETS

● The number and type of AC outlets provided on the unit differ according to sales area.

(U.S.A., Canada and General models: switched x 2, unswitched x 1

Europe, U.K. and Australia models: switched x 1)

These outlets are used to connect the power cords from your components to the amplifier.

The power to the SWITCHED outlets is controlled by the amplifier's power switch. These outlets will supply power to any component that is connected to them whenever the amplifier is turned on, whether by the front panel POWER switch or by the remote control transmitter POWER key. The total maximum power consumption of the components attached to these outlets must not exceed 100 watts.

The power to the UNSWITCHED outlet is not controlled by the amplifier. This outlet will continually supply power to any unit connected to it regardless of the setting of the amplifier's power switch. The maximum power consumption of the component connected to this outlet must not exceed 200 watts.

USING THE REMOTE CONTROL TRANSMITTER

25 AC power cord

This cord is used to connect the amplifier to an AC wall outlet.

26 SPEAKERS terminals

These terminals are used to connect one pair of front speakers, one pair of rear speakers, and a center speaker. See the "SYSTEM POSSIBILITIES AND SPEAKER CONNECTIONS" section for details on speaker connections.

27 OUTPUT jacks

- If you wish to drive rear speakers and/or a center speaker with another power amplifier, use these jacks. For details, see the "SYSTEM POSSIBILITIES AND SPEAKER CONNECTIONS" section.

REAR OUTPUT jacks — Connect these output jacks to the left and right channel input jacks of the power amplifier that will drive your rear speakers.

CENTER OUTPUT jack — Connect this output jack to the input jack on the center channel power amplifier.

LOW PASS jack — Use this jack for output to a Yamaha electronic super woofer system or to a mono amplifier driving a subwoofer. Frequencies above 200 Hz are filtered out so only the low bass range remains.

28 S VIDEO connectors

These connectors are used to connect to a TV/monitor, Video Cassette Recorder or Laser Vision Disc player equipped with S connectors.

29 CARTRIDGE holder (only for Active Servo Technology system speakers)

If your front speakers are Active Servo Technology system exclusive speakers (YST-SF50, etc.), insert the cartridge supplied with Active Servo Technology system speakers in this holder. For details, see the Owner's Manual supplied with your Active Servo Technology system speakers.

(See Fig. 4.)

The remote control transmitter supplied with your amplifier is designed to control all the most commonly used features of the amplifier. If the CD player, LD player, CD/CDV/LD compatible player, tuner, turntable and cassette deck connected to your amplifier are YAMAHA components designed for remote control compatibility (components with an **RC** mark), then this remote control transmitter will also control various functions of each component. Please consult your YAMAHA dealer for information on which components are compatible with the remote control transmitter. Note that this Remote Control transmitter will directly operate compatible YAMAHA CD player, LD player, CD/CDV/LD compatible player, and some Tuners or Cassette Decks bearing the **RC** mark and having the remote sensor.

NOTE:

This remote control transmitter has a learning function. For details, refer to the "HOW TO USE THE LEARNING FUNCTION" section described later.

■ OPERATION KEYS

① LD player keys

LD/CDV:

To monitor the Laser Vision Disc player, press this key.

OPEN/CLOSE:

Press this key to open/close the disc tray.

PAUSE/STOP:

Press this key once to temporarily stop the player operation. When it is pressed again, the player enters stop mode.

PLAY:

Press this key to start play. If this key is pressed when the disc tray is opened, the disc tray will close and the unit will enter play mode. When this key is pressed during other modes (pause, still, etc.), that mode is released and play is resumed.

CHAPTER:

Press the - key to detect the beginning of the current chapter. If it is kept pressed, the chapter number is reversed continuously.

Press the + key to detect the beginning of the next chapter. If it is kept pressed, the chapter number is advanced continuously.

SEARCH:

When the ◀◀ key is pressed during play, play is reversed at high speed.

When the ▶▶ key is pressed during play, play is advanced at high speed.

STILL (for CAV disc only):

When one of these keys is pressed during CAV disc play, the picture freezes. Every time the ◀ key is pressed again, the picture reverses frame-by-frame. Every time the ▶ key is pressed again, the picture advances frame-by-frame.

SOUND:

Every time this key is pressed, the audio signal changes in the order: STEREO → 1/L-CH → 2/R-CH → STEREO.

DISPLAY:

When this key is pressed during play, the monitor screen shows the following data.

With LD/CDV-LD (CAV) discs:

Chapter and frame numbers

With LD/CDV-LD (CLV) discs:

Chapter and time numbers

With CD discs or the audio section of CDV discs:

Total time, remain time or track time

With the video section of CDV discs:

Track/index numbers and track time

② SURROUND keys

ON/OFF:

When surround sound is desired, press this key. The last selected surround mode is automatically set.

When surround sound is not desired, press this key again.

MODE:

Press these keys to select the surround program.

REAR LEVEL:

These keys are used to adjust the volume level of the rear speakers. Press the UP key to raise the volume level and press the DOWN key to lower it.

CENTER LEVEL:

These keys are used to adjust the volume level of the center speaker. Press the UP key to raise the volume level and press the DOWN key to lower it.

DELAY TIME:

These keys are used to adjust the delay time of the rear speakers. Press the UP key to increase the delay time and press the DOWN key to reduce it.

③ Turntable keys

PHONO:

Press this key to monitor a turntable.

PLAY/CUT:

This key is used to control the start and stop operations of a turntable bearing the **ERS** mark.

④ CD player keys

CD:

Press this key to monitor a compact disc player.

SKIP:

Press the ◀◀ key to return to the beginning of the current selection. When this key is pressed at the beginning of a selection, play will start at the beginning of the previous selection.

Press the ▶▶ key to advance to the beginning of the next selection.

SEARCH:

Press the ◀◀ key to fast-reverse play, and press the ▶▶ key to fast-forward play.

DISC:

When a CD player which has an Auto charger mechanism is used, press these keys to select the disc No. to be played.

- With carousel-type CD player, the DOWN key does not function.

PAUSE/STOP:

Press this key once to temporarily stop play and press it again to completely stop play.

PLAY:

Press this key to start play. If this key is pressed when the disc tray is opened, the tray will close and the unit will enter play mode. When this key is pressed during pause mode, play will be resumed.

⑤ Tuner keys

TUNER:

Press this key to monitor a radio program.

PRESET A/B/C:

This key is used to change the preset station range.

PRESET UP/DOWN:

These keys are used to select the preset station frequency.

⑥ Tape deck keys

TAPE 1/TAPE 2 MONI:

To monitor the cassette tape deck connected to the TAPE 1 or TAPE 2 jacks, press the corresponding key. When recording onto a cassette tape deck connected to the TAPE 2 jacks, the sound to be recorded can be heard by pressing the TAPE 2 MONI key.

DIR A key (for a double cassette deck only):

Press this key to change the tape running direction of DECK A.

PLAY key:

Press this key to start tape play or to begin recording from Rec Standby mode or Rec Pause mode.

DIR B (for a double cassette deck only):

Press this key to change the tape running direction of DECK B.

DECK A/B key (for a double cassette deck only):

Press this key to select which deck is to be operated, either DECK A or DECK B.

REC/PAUSE key:

Press this key to put the deck into Rec Standby mode or Rec Pause mode.

REC MUTE key:

Press this key to make a blank section during recording.

▶▶ and ◀◀ key:

These keys are used with a deck that has a Direction button. Press either the ▶▶ or ◀◀ key, the one pointing in the same direction as the Direction indicator, to fast-forward a tape. To fast-rewind a tape, press either the ▶▶ or ◀◀ key, the one pointing in the opposite direction as the Direction indicator.

If you deck has no Direction button, press the ▶▶ key to fast-forward a tape and press the ◀◀ key to fast-rewind a tape.

STOP key:

Press this key to stop a tape.

⑦ VOLUME control keys

These keys are used to increase or decrease the output volume level of front and rear speaker pairs and center speaker.

⑧ AUX/VCR 1/VCR 2 keys

To monitor the equipment connected to the AUX, VCR 1 or VCR 2 jacks of this unit, press the corresponding key.

⑨ BASS and TREBLE keys

Pressing the BASS UP key increases the low frequency response. Conversely, pressing the BASS DOWN key decreases it.

Pressing the TREBLE UP key increases the high frequency response.

Conversely, pressing the TREBLE DOWN key decreases it.

⑩ MUTING key

This key is used to lower the output volume of the amplifier to a $-\infty$ dB level.

⑪ POWER key

This key is used to turn the unit on and off.

■ BATTERY INSTALLATION (See Fig. 5.)

The remote control unit uses 4 batteries (size "AA", R06). Install them according to the illustration. Be sure that they are installed correctly.

■ BATTERY REPLACEMENT

When the remote controllable distance decreases the batteries are exhausted.

Replace with 4 new batteries.

Install the batteries with the correct + and - polarities as indicated in the battery compartment.

BATTERY PRECAUTIONS

Incorrect use of a battery may result in personal injury or remote control transmitter damage. Be aware of the following measures:

- Read all safety labels on batteries.
- Do not use an old battery with a new one.
- Do not mix battery types (alkaline, heavy duty, carbon, nickel cadmium, etc.).
- Do not short circuit, heat, disassemble, or dispose of batteries into a fire.
- If leakage occurs, thoroughly wipe off all electrolyte residue from the battery compartment. Replace with new batteries.

■ OPERATION RANGE (See Fig. 6.)

You must point the remote control unit toward the amplifier and be within about 7 meters (23 feet) of it for proper operation.

SPEAKERS AND SPEAKER PLACEMENT

In a full 5-channel system you will use two sets of stereo speakers: the front main speakers, the rear surround speakers, and the center speaker. You may also be using a subwoofer.

You can use Active Servo Technology system speakers or conventional stereo speakers for the front main speaker pair. The rear and center speakers do not need to be of such high quality. However, if a separate power amplifier is used to drive the rear and center speakers, the speakers should have a sufficiently high power handling capacity to accept the maximum output of the amplifier that will drive them. The rear channel output is filtered so that it covers only the frequencies between 100 Hz and 7 kHz. Therefore, you do not need to worry about reproduction of the high treble and low bass tones — they are not present in the surround channel signal.

Place the front main speakers in their normal position.

Place the rear surround speakers behind your listening position and facing inward. They should be placed approximately six feet (1.8 m) up from the floor.

If you use two sets of surround speakers, place the second pair for even greater effectiveness.

Place the center speaker precisely between the two front main speakers. (To avoid interference, keep the speaker away from TV sets, or use a magnetically shielded speaker.)

If you are using a subwoofer such as a Yamaha electronic super woofer system, the position of the speaker is not critical because low bass tones are not highly directional.

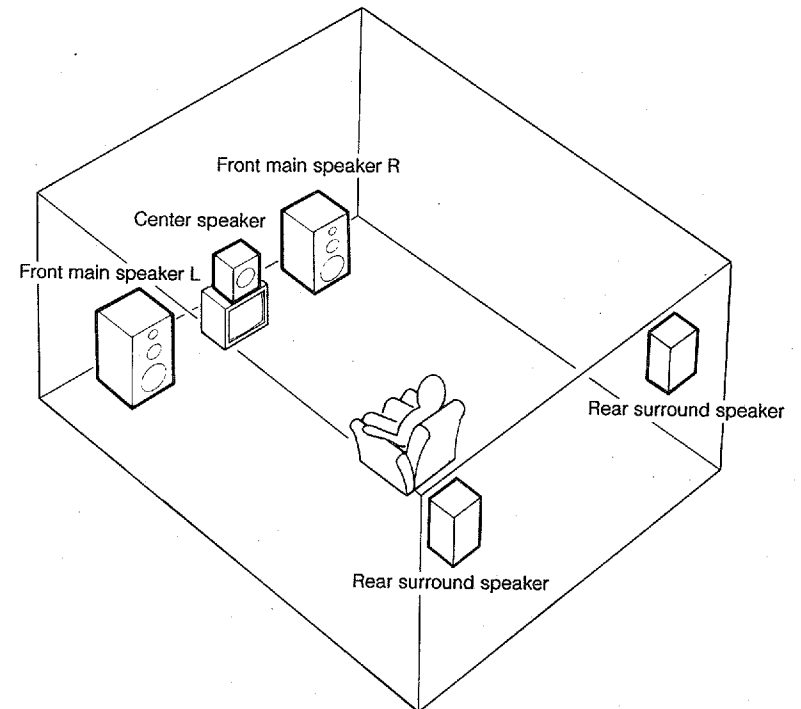

SYSTEM POSSIBILITIES AND SPEAKER CONNECTIONS

The Basic System

To achieve the dynamic sound, the Dolby Pro Logic Surround circuit built into this unit breaks the Dolby Surround encoded stereo signal into several different channels: a center channel for dialog, the front main left and right channels, and rear surround channels. A typical system setup includes five speakers. This unit provides five channels of amplification to satisfy this typical system. The center dialog speaker is placed adjacent to the screen, the front main speakers are placed in their usual positions for stereo listening, and the rear surround speakers are placed at the left and right sides to the rear of the listening position. If for some reason it is not practical for you to use five speakers for your surround system, you can eliminate the center dialog speaker. In this case, use the "Phantom" mode to route the dialog to the front main speakers. However, the best results are obtained with a full five-speaker system. It is also possible to further expand your system with the addition of a subwoofer and amplifier.

5-CHANNEL SYSTEM (ONE PAIR OF FRONT MAIN SPEAKERS + ONE PAIR OF REAR SPEAKERS + ONE CENTER SPEAKER)

- True center channel capability is one of the most important features of the Dolby Pro Logic Surround system.

- ① This unit can be used as an Integrated Amplifier for driving the front main speakers, the rear surround speakers and the center speaker.

To set up this system:

1. Connect the front main speakers to the FRONT SPEAKERS terminals.
2. Connect the rear surround speakers to the REAR SPEAKER terminals.
3. Connect the center speaker to the CENTER SPEAKERS terminals.

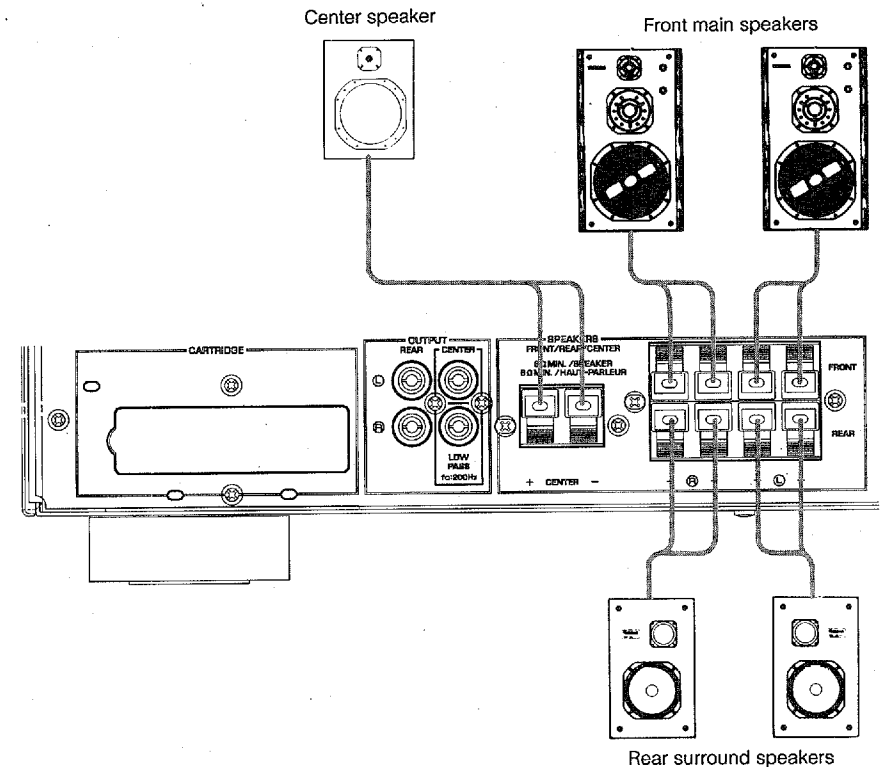

- ② This unit can also be used as an Integrated Amplifier using two separate power amplifiers for both the rear surround speakers and the center speaker.

To set up this system:

1. Connect the REAR OUTPUT jacks to the input jacks of a 2-channel power amplifier. Connect the rear surround speakers to the speaker terminals of the power amplifier.
2. Connect the upper CENTER OUTPUT jack to the input jack of a mono power amplifier. Connect the center speaker to the speaker terminals of the power amplifier.
3. Connect the front main speakers to the FRONT SPEAKERS terminals of this unit.

NOTE:

When the REAR OUTPUT jacks and/or CENTER OUTPUT jack is connected, the signal at the REAR SPEAKERS and/or CENTER SPEAKERS does not output.

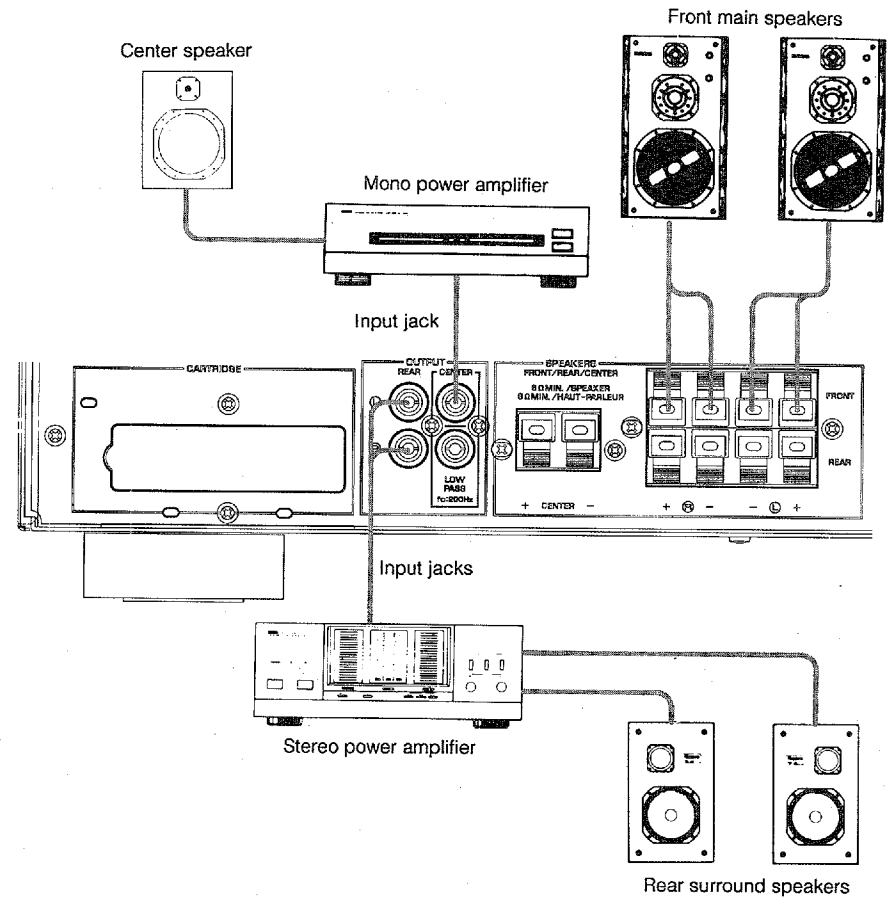

Notes on subwoofer and center speaker

The lower CENTER OUTPUT jack marked "LOW PASS fc:200 Hz" is used for connecting to a subwoofer. A Yamaha electronic super woofer system is highly suited to this purpose since it combines a mono power amplifier and subwoofer speaker in a single cabinet.

- The signals from these jacks are monophonic, so separate mono amplifiers are recommended to provide independent amplification. The use of a stereo power amplifier to handle both of these mono signals is another alternative.

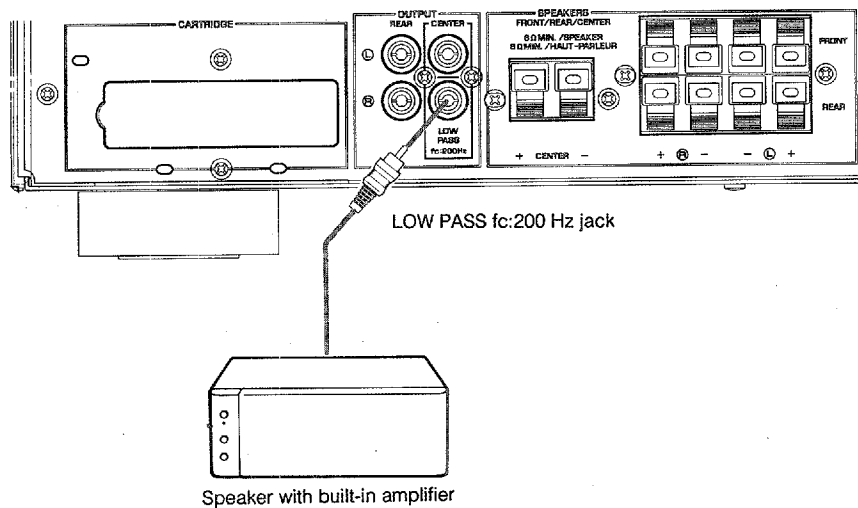

SPEAKER CONNECTIONS

Follow these points when making SPEAKERS FRONT, REAR, and CENTER terminal connections.

- * When connecting the speaker terminals to your speakers, use wire of the proper gauge which is cut to be as short as possible.
- * Make sure that the polarity of the speaker wires is correct; that is, that the + and - markings are observed. If the speakers wires are reversed, the sound will be unnatural and lack bass.
- * Do not coil up any excess speaker wire or bundle the speaker cables with the power cords.
- * Strip approximately 3/8" (10 mm) of the insulation from the end of the speaker cords (regardless of their gauge).

Press the SPEAKERS terminal tabs down, then insert the stripped ends of the wires into the terminals and secure them by releasing the tabs. If these connections are faulty, no sound will be heard from the speakers.

- * If the rear and/or center speakers are connected to a separate power amplifier, observe the proper speaker connection procedures for the power amplifier.

When using Active Servo Technology system speakers

Active Servo Technology system exclusive speakers (YST-SF50, etc.) can be used for the front main speaker pair. If Active Servo Technology system speakers are used, insert the cartridge supplied with the speakers into the CARTRIDGE holder.

NOTE:

When using conventional speakers for the front main speakers, remove the cartridge from the CARTRIDGE holder.

Active Servo Technology system

The theory of the Active Servo Technology system is based upon two major factors, the Helmholtz resonator and negative-impedance drive. Active Servo Technology speakers reproduce the bass frequencies through a port, which is a small port or opening in the speaker's cabinet. This opening is used instead of, and performs the functions of, a woofer in a conventionally designed speaker system. Thus, signals of low amplitude within the cabinet can, according to the Helmholtz resonance theory, be output from this opening as waves of great amplitude if the design is such that the size of the opening and the volume of the cabinet are in the correct proportion to satisfy a certain ratio.

In order to accomplish this, moreover, the amplitudes within the cabinet must be both precise and of sufficient power because these amplitudes must overcome the "load" presented by the air that exists within the cabinet.

Thus it is that this problem is resolved through the employment of a design in which this Stereo Amplifier functions to supply the signals. If the electrical

resistance of the voice coil is reduced to zero, the movement of the speaker unit would become linear with respect to signal voltage, and, to accomplish this, a special negative-impedance output-drive amplifier for subtracting output impedance of the receiver is used.

By employing negative-impedance drive circuits, this amplifier is able to generate precise, low-amplitude low-frequency waves with superior damping characteristics, and these waves are then radiated from the cabinet opening as high-amplitude signals. The system can, therefore, by employing the negative-impedance output drive amplifier and a speaker cabinet with the Helmholtz resonator, reproduce an extremely wide range of frequencies with amazing sound quality and less distortion.

The features described above, are combined to the fundamental structure of the Active Servo Technology system.

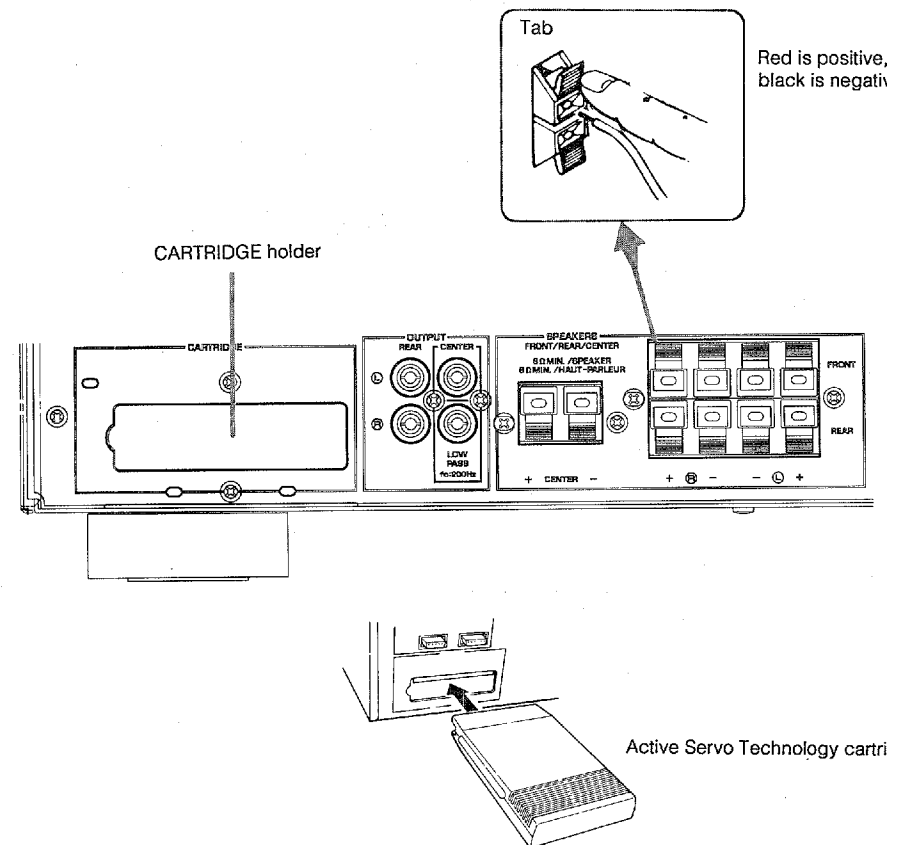

CONNECTIONS

System Connection Diagram

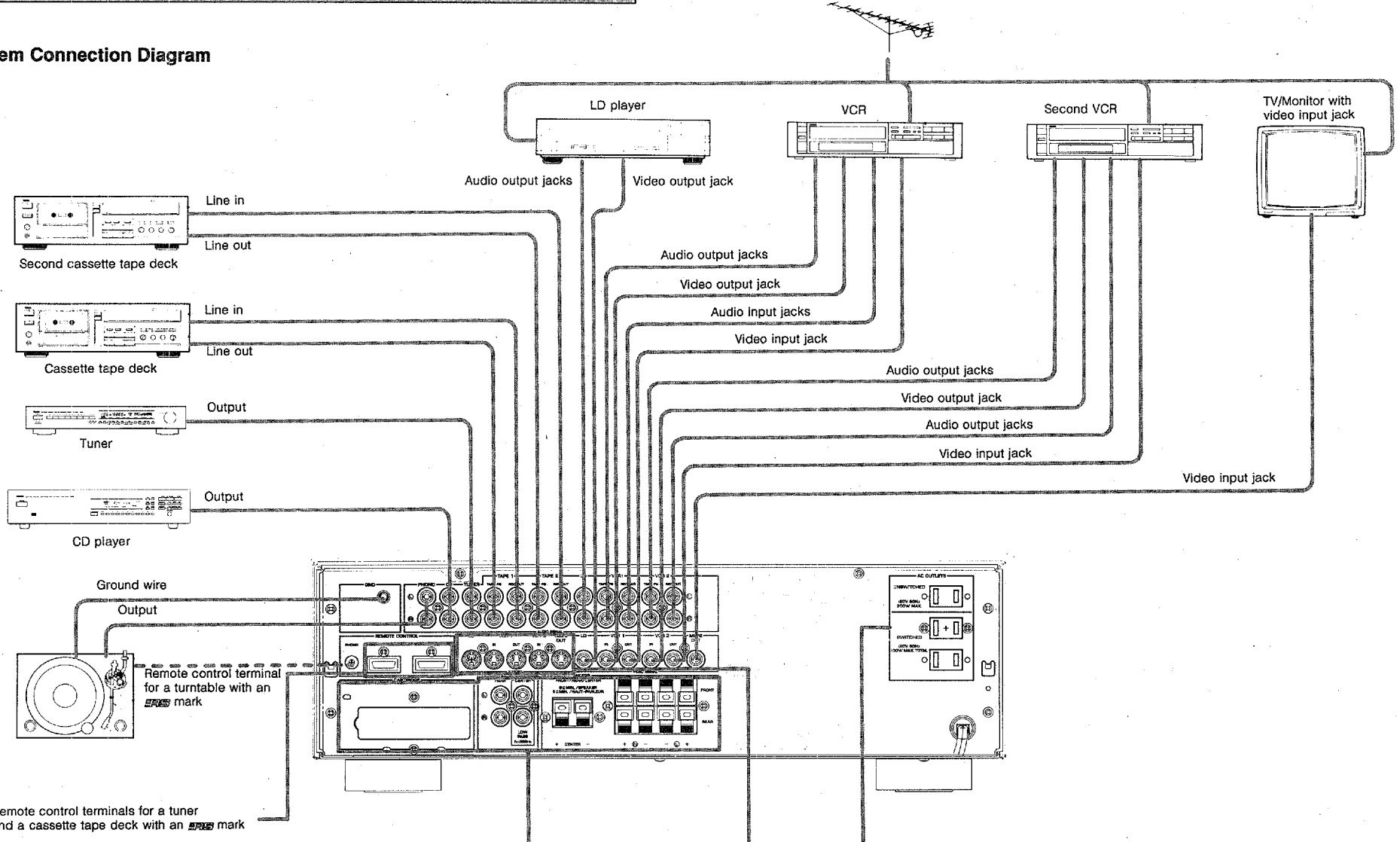

Remote control terminals for a tuner and a cassette tape deck with an **RFMS** mark

Note that the remote control transmitter will directly operate some tuners or cassette tape decks bearing the **RFMS** mark. For these components, the remote control cable connections are not necessary. When a tuner or a cassette tape deck equipped with a remote control terminal and bearing the **RFMS** mark is used, connect the component's remote control terminal to the REMOTE TUNER or REMOTE TAPE 1/2 terminal of this unit.

For connections of these parts, see the "SYSTEM POSSIBILITIES AND SPEAKER CONNECTIONS" section located previously in this manual and set up your system.

S VIDEO connectors

These connectors are used to connect to a TV/monitor, video cassette recorder, or LD player equipped with S connectors. For details, refer to the "CONNECTIONS FOR EACH COMPONENT" section.

Power outlet(s) for other components UNSWITCHED (U.S.A., Canada and general models only):

Handles up to 200 W.
Not linked to the POWER switch of this unit.
SWITCHED:
Handles up to 100 W.
Linked to the POWER switch of this unit.

CONNECTIONS FOR EACH COMPONENT

- Remember to turn off the power to all of the units before making any connections.
- For audio component connections, make sure that the left (L) and right (R) channels are correctly connected. That means that a jack marked "L" on this unit must be connected to the corresponding jack marked "L" on the audio component. Likewise with the "R" jacks. Incorrect connections can be avoided by always using the red plugs for the "R" jacks and the other plugs for the "L" jacks. By convention, the "R" jacks are located below the "L" jacks on this unit.
- When making the connections, make sure that all of the cables are well away from sources of hum, such as the power cords or power transformers of other components.

Notes on REMOTE CONTROL terminals

The REMOTE CONTROL terminals are used when you have YAMAHA compatible components equipped with the remote control terminal and bearing the **ERS** mark. These terminals allow you to control the connected components with the supplied remote control transmitter.

Connect the remote control cables from the components to the correct terminals on your amplifier (i.e. PHONO, TUNER, TAPE).

Note that no cable is necessary for a CD, LD player, some tuners or cassette tape decks as the remote control transmitter operates the equipment directly.

AUDIO COMPONENTS

■ TURNTABLE

Connect the output cables of the turntable to the PHONO jacks, and connect the ground wire to the GND terminal on the rear panel of this unit. This should produce minimum hum, but in some cases better results are obtained with this wire disconnected. When a turntable bearing the **ERS** mark is used, connect the remote control terminal on the turntable to the REMOTE CONTROL PHONO terminal on the rear panel of this unit, using the remote cable with mini-plug.

■ COMPACT DISC PLAYER

Connect the output jacks of the compact disc player to the CD jacks on the rear panel of this unit.

- The digital input jacks are not equipped with this unit.

■ TUNER

Connect the output jacks of the tuner to the TUNER jacks on the rear panel of this unit.

When a tuner equipped with the remote control terminal and bearing the **ERS** mark is used, connect the remote control terminal on the tuner to the REMOTE CONTROL TUNER terminal on the rear panel of this unit, using the 5-pin remote control cable.

- * If your tuner bears the **ERS** mark, and it can be directly operated with the remote control transmitter, the remote control cable connections are not necessary.

■ TAPE DECK

Connect the cable from a cassette tape deck, or other audio tape unit, to the TAPE 1 jacks and connect a second cassette tape deck or another audio tape unit to the TAPE 2 jacks. The playback (LINE OUT) jacks of the cassette deck go to the TAPE PB jacks, and the record (LINE IN) jacks go to the REC OUT jacks on the rear panel of this unit. When a cassette deck equipped with the remote control terminal and bearing the **ERS** mark is used, connect the remote control terminal on the cassette deck to the REMOTE CONTROL TAPE 1/2 terminal on the rear panel of this unit, using the 6-pin remote control cable.

- * If your cassette tape deck bears the **ERS** mark, and it can be directly operated with the remote control transmitter, the remote control cable connections are not necessary.

VIDEO COMPONENTS

■ LD (Laser vision Disc player)

Connect the video output jack from your LD player to the LD video jack and connect the audio output jacks from the LD player to the LD audio jacks.

Using the S VIDEO connector

When an LD player that has an S connector is used, connect the S connector of the player to the S VIDEO LD connector of this unit. With S VIDEO connections, a high resolution picture is obtained, resulting in much clearer image reproduction.

- Even when using the S VIDEO connection, retain the conventional LD video and audio jack connections between the LD player and this unit.

■ VIDEO COMPONENTS

Connect the video jacks of the VCR to the VCR 1 jacks, and connect the video jacks of a second VCR to the VCR 2 jacks on the rear panel of this unit. The video playback (VIDEO OUT) jack of the VCR goes to the IN jack, and the video record (VIDEO IN) jack goes to the OUT jack.

Connect the audio output jacks of the VCR to the VCR 1 jacks, and connect the audio output jacks of a second VCR to the VCR 2 jacks.

The audio playback (AUDIO LINE OUT) jacks of the VCR go to the TAPE PB jacks, and the audio record (AUDIO LINE IN) jacks go to the REC OUT jacks.

When using the S connector

When a VCR that has S connectors is used, connect the S VIDEO connectors. With the S VIDEO connections, a high resolution picture will be obtained, resulting in a much clearer reproduction.

Connect the S output connector of the VCR to the S VIDEO IN connector in the VCR 1 section on the rear panel of this unit, and connect the S input connector of the VCR to the S VIDEO OUT connector.

- Keep the VCR IN and OUT jacks, and TAPE PB and REC OUT jacks connected between the VCR and this unit.

If the second VCR has S connectors, connect the S output and input connectors to the S VIDEO IN and OUT connectors in the VCR 2 section on the rear panel of this unit in the same way.

■ TV/MONITOR

Connect the video jack from the TV/monitor to the MONI OUT jack on the rear panel of this unit. Note that audio connections to the monitor are not necessary, as the audio portion of the signal is sent to your speakers through the amplifier.

When using the S connector

When a monitor that has an S video connector is used, connect S VIDEO MONI OUT connector.

With the S VIDEO connections, a high resolution picture will be obtained, resulting in a much clearer reproduction.

■ OTHER VIDEO SOURCE

If necessary, you can connect a third video input source, such as a video camera, to the AUX jacks on the front panel of this unit. When connecting a mono audio source, connect it to the L jack.

S VIDEO connector and VIDEO SIGNAL jacks

- The S VIDEO input/output connector and the conventional RCA pin-type video signal jacks provided on this unit are connected to completely separate circuits and function independently of each other.
- The input selector is coupled to both the S VIDEO inputs and the pin-jack inputs. When a program source with no S VIDEO input is selected, no signal is output to the MONI OUT S VIDEO connector.
- In cases where both the S VIDEO input connector and the pin-type input jack of VCR1 (or VCR2) are connected, when the input selector is set to VCR1 (or VCR2), signals are output to both the MONI OUT S VIDEO connector and the MONI OUT pin jack. In this case, you must select whether to monitor the S video signal or the pin jack signal on the monitor TV side.

Caution concerning use of S VIDEO connector

Due to the circuit configuration of this unit, do not leave the S VIDEO connection cable plugged into the VCR2 S VIDEO OUT connector if the other end of the cable is not connected to the VCR component.

SURROUND PROGRAMS

POWER CORDS

1. Connect the power cord of your tuner, cassette deck or other component to one of the two SWITCHED AC OUTLETS to automatically turn it on when the amplifier is turned on.
The maximum total power consumption of the components connected to the SWITCHED AC OUTLETS must not exceed 100 watts.
2. Connect the power cord of your VCR or other unit to the UNSWITCHED AC OUTLET (U.S.A., Canada and general models only) to supply power to it constantly. The maximum power consumption of the unit connected to the UNSWITCHED AC OUTLET must not exceed 200 watts.
3. Make sure that the power cords are not tied together with the input/output cables.
4. Connect the power cord of your amplifier to an AC outlet.

Dolby Pro Logic Surround

The Dolby Pro Logic Surround system is designed for use with program material (mainly videotaped movie soundtracks) encoded with the Dolby Surround system. When playing these program sources, use this mode.

Simulated Surround

This mode is designed to enhance mono source programs. Since this mode creates a more expansive sound image, it can also be used to advantage with stereo programs. Compared to a strictly mono setting, the sound image created in this mode is wider and slightly forward of the speaker pair, lending an immediacy to the overall sound.

Live Surround

This mode takes advantage of the delay signal and a feedback circuit for the rear surround speakers to create a bright, lingering, and somewhat resonant sound that characterizes a small concert space.

Hall Surround

In this mode, the center image seems to be located even more deeply behind the front main speaker pair, creating an expansive, large hall ambience. The apparent listening position is in the center of the hall rather than in front of the stage.

PREPARATION FOR THE BEST SURROUND CONDITION

This preparation is important for proper Dolby Pro Logic Surround operation.

■ INPUT BALANCE AND FRONT MAIN/CENTER/REAR SURROUND SPEAKER BALANCE ADJUSTMENTS

1. Press the **PRO LOGIC** button and then press the **CENTER MODE** button so that the **CENTER MODE OFF** indicator lights.
2. Use the input selector to select a component which can play a Dolby Surround encoded program and begin playback of the Dolby Surround encoded program.
3. While listening to spoken dialog, adjust the **INPUT BAL** control so that the dialog volume (heard from the left and right main and surround speakers) is reduced to the minimum level. (During normal operation, this dialog is reproduced from the center speaker.)
4. Select the Dolby Pro Logic mode with the **CENTER MODE** button. When using a 5-speaker system, press the **CENTER MODE** button so that the **CENTER MODE NORM** indicator lights. When using a 4-speaker system (i.e., no center speaker), press the **CENTER MODE** button so that the **CENTER MODE PHANTOM** indicator lights.
5. Press the **TEST** button.
6. Increase the volume level with the **VOLUME UP** key on the remote control transmitter. You will hear a test tone (pink noise) emitted from the front right main speaker, which then proceeds sequentially to the center speaker, the left main speaker, and then the rear surround speakers, for about two seconds each.
 - When using a 4-speaker system (Phantom mode), you will hear the center channel test tone from both the front left and front right main speakers.
7. Adjust the **VOLUME** control, **CENTER LEVEL**, and/or **REAR LEVEL** keys on the remote control transmitter so that the volume heard at the listening position is the same from each speaker.
 - If you wish to adjust the relative volume levels of the left and right rear speakers, press the **REAR BALANCE** button and adjust the levels with the **LEVEL/R.BAL/D.TIME** buttons. Pressing the **◀** button shifts the sound image to the left. Pressing the **▶** button shifts the sound image to the right.
8. After completing this adjustment, press the **TEST** button again.

NOTE:

Once you have completed these adjustments, use only the **VOLUME** control of this unit.

Do not change any other volume settings in the system.

OPERATION

PLAYBACK WITH SURROUND MODE

1. Turn on the power of all components to be used in the system.
2. Select a Surround Mode.

With Dolby Surround

Press the **PRO LOGIC** button and then select the center mode with the **CENTER MODE** button. When using a 5-speaker system, press the **CENTER MODE** button so that the **CENTER MODE NORM** indicator lights. When using a 4-speaker system, press the **CENTER MODE** button so that the **CENTER MODE PHANTOM** indicator lights.

With another Surround Mode (SIMULATED SURROUND, LIVE, or HALL)

Press the **SIMULATED SURROUND** button, **LIVE** button, or **HALL** button according to the Surround mode to be used.

- When a Surround Mode other than **PRO LOGIC** is selected, the **CENTER MODE** button does not function even when a 5-speaker system is used.
3. Select the program source with the input selectors.
 4. Play the program source.
 5. Adjust the **VOLUME** control to increase or decrease the overall output volume level of the speakers.
 6. Adjust the tone, if necessary. For adjusting low frequency response, press the **BASS** button and then adjust the level with the **LEVEL/R.BAL/D.TIME** (**◀**, **▶**) controls. For adjusting high frequency response, press the **TREBLE** button and then adjust the level with the **LEVEL/R.BAL/D.TIME** (**◀**, **▶**) controls. Pressing the **▶** button increases the level, and pressing the **◀** button decreases the level. The "DEFEAT" position produces a flat response.
 - When using Dolby Pro Logic Surround, extremely cutting or boosting the high or low frequency response using the tone controls result in losing the continuity of the sound between center speaker and rear speaker pair.
 7. Adjust the delay time, if necessary. Press the **DELAY TIME** button and then adjust the **LEVEL/R.BAL/D.TIME** (**◀**, **▶**) controls. For details, see the "Delay Time Adjustment" section.

NOTE:

The Dolby Pro Logic Surround system is designed for use with program material (mainly videotaped movie soundtracks) encoded with the Dolby Surround system. If the Dolby Pro Logic Surround system is used with material not encoded with Dolby Surround, the results may be unnatural.

Delay Time Adjustment

The Delay Time Adjustment is effective with all Surround Modes. With Simulated Surround, Live Surround, or Hall Surround mode, the delay time can be adjusted within a range of 5 mS to 30 mS. With Dolby Pro Logic Surround Normal or Phantom mode, the delay time can be adjusted within a range of 15 mS to 30 mS.

By applying a stronger or weaker delay sound effect, the background noise and ambient noise coming at you from the rear speakers can be enhanced or subdued for extra effect. Adding too much delay will cause an unnatural effect with some sources. Experiment with the delay time adjustment to create the effect that you find most suitable.

PLAYBACK WITHOUT SURROUND MODE

1. Turn on the power of all components to be used in the system.
2. If the Surround PROGRAM indicator is lit, press the Surround PROGRAM OFF button.
3. Select the desired program source with the input selectors.
4. Play the program source.
5. Adjust the VOLUME control to increase or decrease the overall output volume level of the speakers.
6. Adjust the tone, if necessary. For adjusting low frequency response, press the BASS button and then adjust the level with the LEVEL/R.BAL/D.TIME (◀, ▶) controls. For adjusting high frequency response, press the TREBLE button and then adjust the level with the LEVEL/R.BAL/D.TIME (◀, ▶) controls. Pressing the ▶ button increases the level, and pressing the ◀ button decreases the level. The "DEFEAT" position produces a flat response.
7. Adjust the CENTER LEVEL and REAR LEVEL controls, if necessary.

NOTE:

Whenever the power is turned on, the state of the last surround program is automatically set.

RECORDING

1. Turn on the power of all components to be used in the system.
2. **To record an audio program source or a video program source**
Select the audio program source or video program source to be recorded with the audio or video input selector.
 - When recording a video program source, press the COPY button to lock in the selected recording position. When the COPY button is pressed, this unit outputs only the selected video signal at the REC OUT jacks and other video input selectors cannot function. Thus, if you wish to listen to an audio program while recording a video program source, select the audio program with the input selector.
 - Make sure that only the selected video input indicator lights when recording a video program source. If an audio input indicator is lit, press the selected video input selector again. The audio input indicator will go out.
To record the video portion of a video program source mixed with audio from a separate audio program source
Select the video program source with the video input selector and then select the audio program source with the audio input selector.
- Be sure to select the video source first. Otherwise, the indicator of the selected audio source goes off and the signal of the audio source cannot be input.
- Make sure that the COPY button is turned off.
3. Play the program source to be recorded and set the cassette tape deck or video cassette recorder to record mode.
- If your cassette tape deck is connected to the TAPE 2 jacks on the rear panel you can monitor the sound to be recorded during recording by pressing the TAPE 2 MONI selector. To listen to the source sound, press the TAPE 2 MONI selector again.

NOTE:

The settings of the various controls and buttons on this unit do not affect the recording.

HOW TO USE THE LEARNING FUNCTION

The supplied remote control transmitter is a "learning" remote control unit that allows for centralized control of various Audio/Visual equipment, solving the complicated problem of operating several remote controllers for your system.

NOTES

- If the indicators are only dimly lit when pressing a key, the batteries are weak. Replace the batteries.
- All memorized functions will be retained while you replace the batteries. However, if no batteries are installed for an hour, the memory will be erased and will have to be programmed again.

CONTROLS AND FUNCTIONS

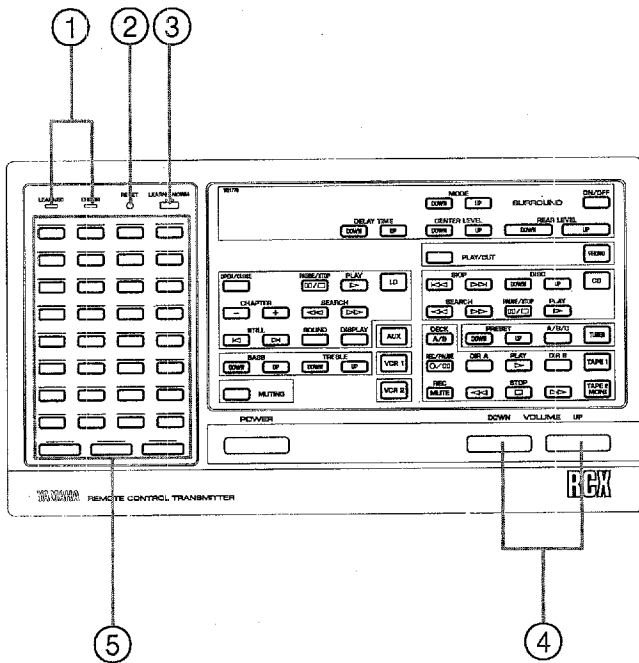

① LEARNED and ERROR indicators

These indicators show the operation mode of the remote control transmitter.

② RESET button

Used to clear a programmed signal.

③ LEARN/NORM switch

This switch is used to select between LEARN (program) and NORM (control) modes.

④ VOLUME UP DOWN (preset/learning) keys

These keys have already been preset with signals for controlling volume up/down.

However, if desired, other signals can be "learned" by these keys (over the preset signals), in the same way as for the ordinary learning keys.

⑤ Learning keys (35 keys)

These keys can be used to "learn" (program) signals from another remote controller.

OPERATIONS

To program the signals of another remote controller in this remote control unit, please follow the steps below.

1. Switch the LEARN/NORM switch to the LEARN position.

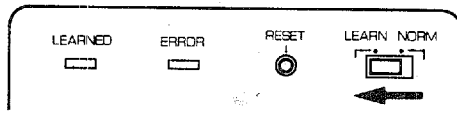

2. Position this remote control unit and the remote controller unit to be memorized head to head.

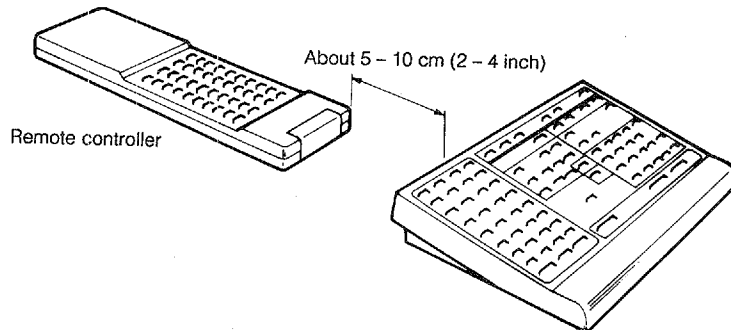

3. Select and press the learning or preset/learning key on this remote control unit to be programmed.

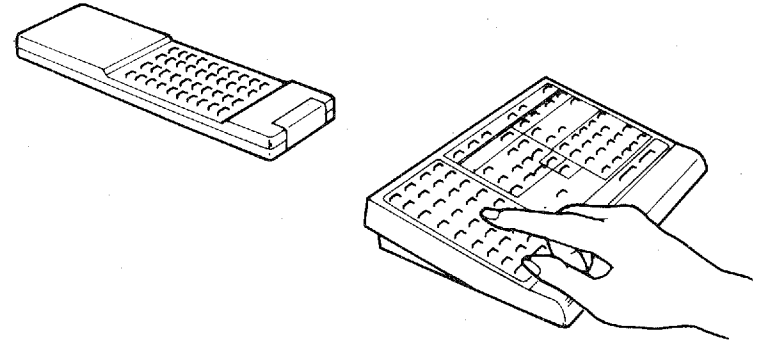

The LEARNED indicator will flash for about 15 seconds. If the ERROR indicator lights up when the key is pressed, a signal has already been programmed in that key. If the programmed signal can be replaced, proceed to the next step.

If the programmed signal cannot be replaced, press another learning or preset/learning key on this remote control unit.

4. While the LEARNED indicator is flashing, press a key on the other remote controller.

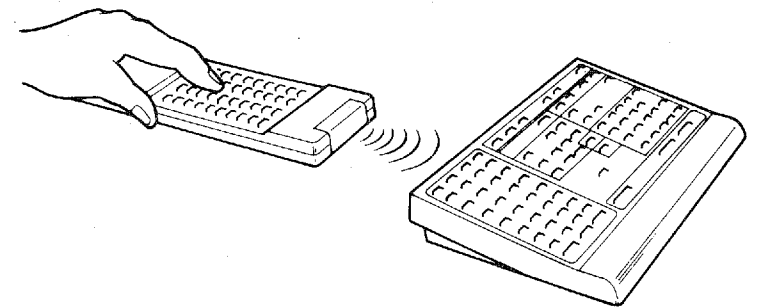

The LEARNED and ERROR indicators will light steadily while receiving the signal. Press the other remote controller's key until these indicators turn off. The LEARNED indicator will light for about 2 seconds when the memorization of a function is successfully complete.

The ERROR indicator will light for about 2 seconds when the memorization of a function is unsuccessful. In this case, please try again.

5. Repeat steps 3 and 4 until all programming is complete.
6. Once programming is complete, set the LEARN/NORM switch to the NORM position.

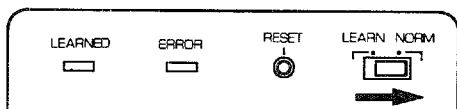

7. Use the supplied seals to indicate the functions for which the learning and preset/learning keys have been programmed. It is recommended that you first determine the best and most convenient layout of the keys for the various functions you plan to program and attach the seals accordingly, then program the keys correspondingly.

If programming is not carried out successfully, or if the remote control operation is not successful although programming was successful, check the following:

- Are the batteries of the other remote controller weak? In this case, even when the other remote controller can operate the unit, its signal strength is too weak for this remote control unit. Replace the batteries of the other remote controller.
 - Is the distance to the other remote controller too small or too large, or are they not in line?
 - Is a strong light, such as direct sunlight, incident on this remote control unit?
- If the signal to be stored is too long.

When the signal to be stored is too long, this remote control unit automatically enlarges the work area capacity and stands by for a second entry. Please try the storage operation again.

If the indicators do not function during programming, remove the batteries and replace them after a few minutes to initialize the remote control transmitter.

TO ERASE A PROGRAMMED SIGNAL

To erase a signal programmed on a learning key or a preset/learning key, proceed as follows.

1. Set the LEARN/NORM switch to the LEARN position.
2. Press the RESET button. The LEARNED and ERROR indicators will flash for about 15 seconds.

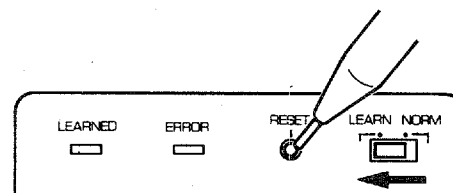

3. While the LEARNED and ERROR indicators are flashing, press the learning or preset/learning key for which you want the programmed signal to be erased. The ERROR indicator will turn off, and then the LEARNED indicator will light up for about 1 second to indicate the completion of the erasure. For the VOLUME UP/DOWN (preset/learning) keys, your programmed signal is erased and the originally preset signal resumes.
4. Repeat steps 2 and 3 for other keys, if necessary.

SPECIFICATIONS

AUDIO SECTION

Minimum RMS Output Power Per Channel

20 Hz - 20 kHz	
0.03% THD, 8 ohms	65W
0.05% THD, 6 ohms	70 W
1 kHz	
1% THD, 8 ohms	14 W
1% THD, 6 ohms	15 W
Dynamic Power Per Channel (by IHF Dynamic Headroom measuring method)	
8 ohms	85 W
6 ohms	105 W
DIN Standard Output Power Per Channel (Europe model only)	
1 kHz, 1% THD, 4 ohms	85 W
Dynamic Headroom	
8 ohms	1.2 dB
6 ohms	1.8 dB
IEC Power (Europe model only)	
1 kHz, 0.03% THD	
8 ohms	70 W
6 ohms	75 W
Damping Factor	
1 kHz, 8 ohms	More than 80
Input Sensitivity/Impedance	
PHONO MM	2.5 mV/47 k-ohms
CD etc.	150 mV/47 k-ohms
Output Level/Impedance	
REC OUT	150 mV/150 ohms
PRE OUT (REAR L/R, CENTER) (Low Pass)	2 V/1 k-ohms 0.7 V/4 k-ohms
Maximum Voltage Output	
20 Hz - 20 kHz, 0.02% THD	4 V
Headphone Jack Rated Output/Impedance	
0.03% THD, 1 kHz, RL=150 ohms	3 V/100 ohms
Frequency Response (20 Hz - 20 kHz)	
CD, etc.	0 ±2 dB

RIAA Equalization Deviation

PHONO MM	0 ±0.5 dB
Total Harmonic Distortion (20 Hz - 20 kHz)	
PHONO MM, 3 V	Less than 0.01%
CD, etc. to Sp Out, 35 W/8 ohms	Less than 0.02%
CENTER Sp Out, 7 W/8 ohms	Less than 0.5%
REAR L/R Sp Out, 7 W/8 ohms (Vol -30 dB, 1kHz)	Less than 0.5%
Signal to Noise Ratio (IHF-A-Network)	
PHONO MM (5 mV Input Shorted)	More than 86 dB
CD, etc.	More than 98 dB
Residual Noise (IHF-A Network)	
Channel Separation (Vol -30 dB)	Less than 150 µV
PHONO MM input shorted, 1 kHz/10 kHz	65 dB/50 dB
CD, etc., input 5.1 k-ohms terminated, 1 kHz/10 kHz	65 dB/50 dB
Tone Control Characteristics	
BASS (boost/cut)	±10 dB (50 Hz
(turnover frequency)	350 Hz
TREBLE (boost/cut)	±10 dB (20 kHz
(turnover frequency)	3.5 kHz
Filter Characteristics	
Subsonic (built-in)	15 Hz, 12 dB/oct
High (surround rear L/R)	7 kHz, 30 dB/oct
Gain tracking error (0 - -60 dB)	Less than 3 dB

VIDEO SECTION

Video Signal Type	NTSC (U.S.A. and Canada models NTSC/PAL (General model PAL (Australia, Europe and U.K. models
Video Signal Input/Output	1 Vp-p, 75 ohms
S-Video Signal Input/Output	Y (Luminance): 1 Vp-p, 75 ohms C (Color): 0.286 p-p, 75 ohms
Maximum Input Level	More than 1.5 Vp-p
Video S/N	More than 55 dB

GENERAL

Power Supply

Europe Model	AC 220V, 50 Hz
General Model	AC 110/120/220/240V, 50/60 Hz
U.K. and Australia Models	AC 240V, 50 Hz
U.S.A. and Canada Models	AC 120 V, 60 Hz

Power Consumption	300W (U.S.A. and General models)
	360 VA (Canada model)
	200 W (Australia, Europe and U.K. models)

AC Outlets

Switched x 2	100W max (Total).
	(U.S.A., Canada and General models)
Switched x 1	100W max.
	(Europe, U.K. and Australia models)
Unswitched x 1	200W max.
	(Except for U.K. model)

Dimensions (W x H x D)	435 x 145 x 377 mm
	(17-1/8" x 5-11/16" x 14-13/16")

Weight	10 kg (22 lbs. 1 oz.)
--------------	-----------------------

Accessories	Remote control cable (mini-plug) x 1
	Remote control cable (5-pin) x 1
	Remote control cable (6-pin) x 1
	Video cord x 1
	Remote control transmitter x 1
	Battery (size "AA", R06) x 4

Specification subject to change without notice.



Manufactured under license from Dolby Laboratories Licensing Corporation.
Additionally licensed under one or more of the following patents: U.S. numbers 3,632,886, 3,746, 792, and 3,959, 590; canada numbers 1,004,603 and 1,037,877. "Dolby" and the double-D symbol are trademarks of Dolby Laboratories Licensing Corporation.

TROUBLESHOOTING

If the unit fails to operate normally, check the following points to determine whether the fault can be corrected by the simple measures suggested. If it cannot be corrected, or if the fault is not listed in the SYMPTOM column, disconnect the power cord and contact your dealer or service center for help.

SYMPTOM	CAUSE	REMEDY
The amplifier fails to turn on when the POWER switch is pressed.	<ul style="list-style-type: none"> ● Power cord is not plugged in or is not completely inserted. 	<ul style="list-style-type: none"> ● Firmly plug in the power cord.
No sound.	<ul style="list-style-type: none"> ● Incorrect output cord connections. 	<ul style="list-style-type: none"> ● Connect cord properly. If the problem persists, the cables may be defective.
	<ul style="list-style-type: none"> ● Incorrect amplifier operation. 	<ul style="list-style-type: none"> ● Set the amplifier controls to the correct input selection.
Sound "hums".	<ul style="list-style-type: none"> ● Incorrect cable connections. 	<ul style="list-style-type: none"> ● Firmly connect the audio plugs. If the problem persists, the cord may be defective.
No picture.	<ul style="list-style-type: none"> ● Incorrect cord connections. ● Wrong video unit selected. ● Video unit not turned on. 	<ul style="list-style-type: none"> ● Connect the video plugs correctly. ● Select correct video unit. ● Turn video unit on.

YAMAHA

YAMAHA ELECTRONICS CORPORATION, USA 6722 ORANGETHORPE AVE., BUENA PARK, CALIF. 90620, U.S.A.

YAMAHA CANADA MUSIC LTD. 135 MILNER AVE., SCARBOROUGH, ONTARIO M1S 3R1, CANADA

YAMAHA ELECTRONIK EUROPA G.m.b.H. 2084 RELLINGEN, BEI HAMBURG, SIEMENSSTR. 22/34, F.R. OF GERMANY

YAMAHA ELECTRONIQUE FRANCE S.A. 17 RUE DES CAMPANULES, LOGNES 77321 MARNE LA VALLEE CEDEX 2, FRANCE

YAMAHA ELECTRONICS (UK) LTD. YAMAHA HOUSE, 200 RICKMANSWORTH ROAD WATFORD, HERTS WD1 7JS, ENGLAND

YAMAHA SCANDINAVIA A.B. J A WETTERGRENS GATA 1, BOX 30053, 400 43 VÄSTRA FROLUNDA, SWEDEN

YAMAHA MUSIC AUSTRALIA PTY, LTD. 17-33 MARKET ST., SOUTH MELBOURNE, 3205 VIC., AUSTRALIA

YAMAHA CORPORATIO

10-1 NAKAZAWA-CHO, HAMAMATSU, JA

VI17230-0 BWgW, BBℓ  Printed in Ja